

# Synchronous Step-Down Converter's Evaluation Board for RT7238 Integrated Chip

## ***Purpose***

The RT7238B/C/D is an advance integrative chip, which includes a LDO regulator and a synchronous Buck converter. This document explains the function and use of the RT7238 evaluation board (EVB) and provides information to enable operation and modification of the evaluation board and circuit to suit individual requirements.

## **Table of Contents**

Purpose .....	1
Introduction.....	2
Application.....	2
Key Performance Summary Table.....	2
Bench Test Setup Conditions .....	3
Schematic, Bill of Materials & Board Layout .....	5
More Information.....	9
Important Notice for Richtek Evaluation Board .....	9

## Introduction

### General Product Description

The RT7238B/C/D is an advanced constant on-time (ACOT™) mode synchronous step-down converter. The main control loop of RT7238B/C/D using an advanced constant on-time (ACOT™) mode control which provides a very fast transient response. The RT7238B/C/D operates from 8V to 23V input voltage. For the RT7238D, the output voltage can be adjusted between 0.6V to 5V. The RT7238B/C/D is available in the UQFN-10L 3x3 (FC) package.

### Product Features

- Advanced Constant On-Time (ACOT) Control
- 8V to 23V (RT7238B/C/D) Input Voltage Range @ 8A Output Current
- ACOT™ Mode Performs Fast Transient Response
- ACOT™ Architecture to Enable all MLCC Output Capacitor Usage
- Fixed 500kHz Switching Frequency
- High Efficient Internal Power MOSFET Switch
  - ▶ 27mΩ (High-Side) and 10mΩ (Low-Side)
- Adjustable Output Voltage from 0.9V to 5V (RT7238D)
- Fixed 3.3V (RT7238B/D) or 5V (RT7238C) LDO Output Supplies 70mA
- Pre-biased Soft-Start Cycle-by-Cycle Over-Current Protection
- Input Under-Voltage Lockout
- Thermal Shutdown
- Output Over/Under-Voltage Protection

### Application

- Industrial and Commercial Low Power Systems
- Computer Peripherals
- LCD Monitors and TVs
- Green Electronics/Appliances
- Point of Load Regulation for High-Performance DSPs, FPGAs, and ASICs

### Key Performance Summary Table

Key Features	Evaluation Board Number : PCB029_V1
Default Input Voltage	8V to 23V
Max Output Current	8A
Default Output Voltage	3.3V (RT7238B) 5.1V (RT7238C) 1.05V (RT7238D)
Default Marking & Package Type	RT7238B/C/D, UQFN-10L 3x3 (FC)
Operation Frequency	500kHz

**Bench Test Setup Conditions**

**Headers Description and Placement**



RT7238B Top View

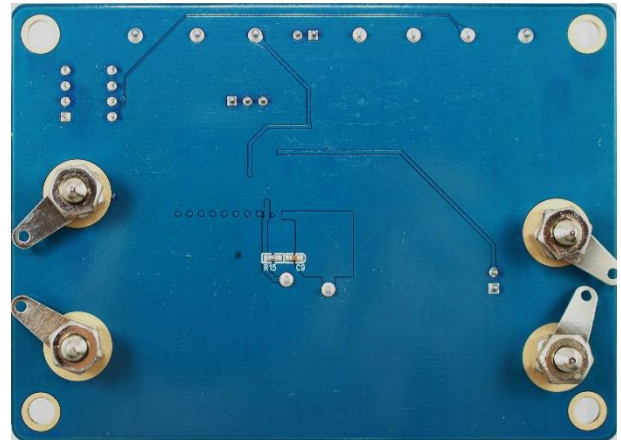

RT7238B Bottom View

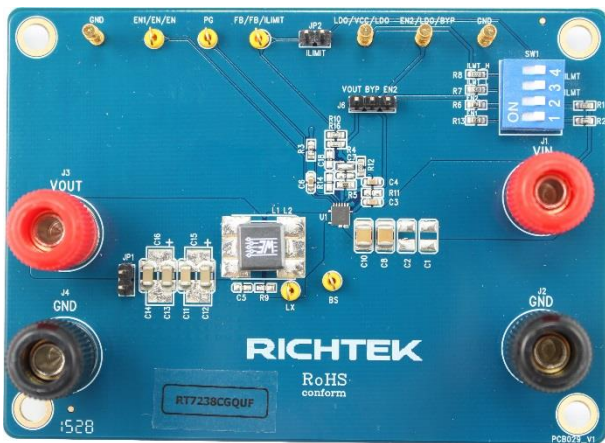

RT7238C Top View

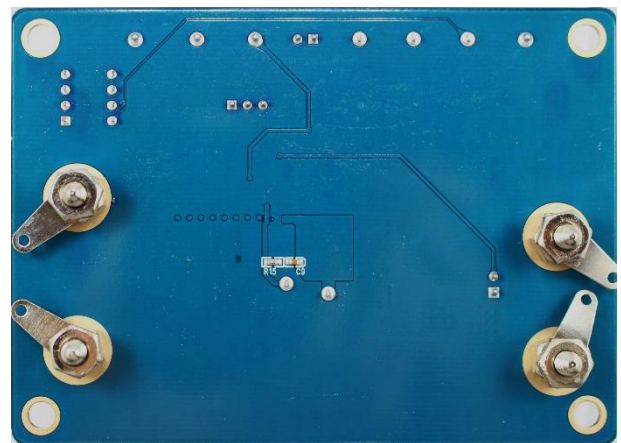

RT7238C Bottom View



RT7238D Top View

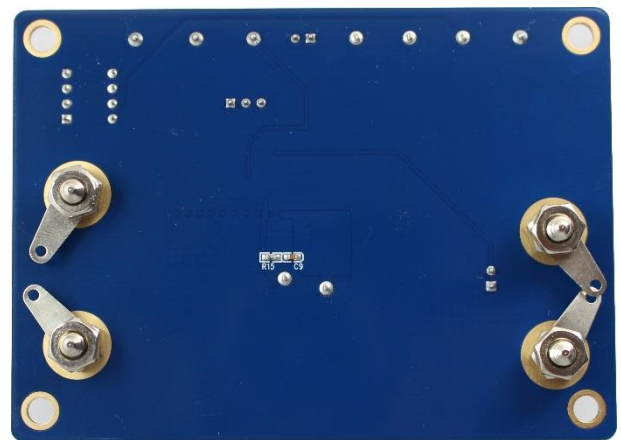

RT7238D Bottom View

Please carefully inspect the EVB IC and external components, comparing them to the following Bill of Materials, to ensure that all components are installed and undamaged. If any components are missing or damaged during transportation, please contact the distributor or send e-mail to [evb\\_service@richtek.com](mailto:evb_service@richtek.com)

### Test Points, Jumpers and Switches

The EVB is provided with the test points, jumpers, switches and individual names listed in the table below.

Test point/ name	Signal	Description (expected waveforms or voltage levels on test points)
<b>VIN</b>	Input voltage	Input voltage range 8V to 23V
<b>VOUT</b>	Output voltage	Output voltage 3.35V(RT7238B), 5.1V(RT7238C), adjustable(RT7238D)
<b>LX</b>	LX voltage	Switch Node
<b>BS</b>	BOOT voltage	Bootstrap supply for high-side gate driver.
<b>EN2/LDO/BYP</b>	EN2/LDO/BYP voltage	Enable Control Input of the IC and Internal LDO for RT7238B Internal 5V LDO Output for RT7238C Bypass Input for the Internal LDO for RT7238D
<b>LDO/VCC/LDO</b>	LDO/VCC/LDO voltage	Internal 3.3V LDO Output for RT7238B/D No Internal Connection for RT7238C
<b>FB/FB/ILMIT</b>	LDO/VCC/LDO voltage	Current Limit Setting for RT7238D No Internal Connection for RT7238B/C
<b>PG</b>	PG voltage	Power Good Indicator.This pin connect to LDO output through R3.
<b>EN1/EN/EN</b>	EN1/EN/EN voltage	Enable Control Input of the DC/DC Regulator.
<b>GND</b>	Ground	Ground

Jumpers/ name	Signal	Description (expected waveforms or voltage levels on test points)
<b>JP1</b>	Output voltage	Output voltage 3.35V(RT7238B), 5.1V(RT7238C), adjustable(RT7238D)
<b>JP2</b>	Current Limit Setting voltage	This jumper only provides current limit setting function for RT7238D Please remove R16, short R10 R14 C18 and short this jumper when setting the current limit.
<b>JP3</b>	VOUT/BYP/EN2 voltage	This jumper provides different settings for RT7238B/D. When this EVB applis for RT7238D, this jumper can provide BYP pin bypass to buck output voltage function as BYP shorting to VOUT.When this EVB applis for RT7238B, please short the BYP to EN2.

Switches/ name	Signal	Description (expected waveforms or voltage levels on test points)
<b>SW1</b>	EN1 voltage EN2 voltage ILMT_L voltage ILMT_H voltage	This switch provide EN1, EN2, and current limit setting functions. When this EVB applis for RT7238C/D/E, the EN1 switch is used to enable EN. When this EVB applis for RT7238D, it can set ILMIT pin to "floating" by turn off ILMT_L and ILMT_H, "0" by turn on ILMT_L and turn off ILMT_H and "1" by turn off ILMT_L and turn on ILMT_H. In order to avoid function fail. Please don't turn on ILMT_L and ILMT_H simultaneously.

**Power-up & Operating Guideline**

1. RT7238B starts work by providing VIN voltage then turn on EN1 and EN2 switches. In the RT7238B application, the BYP and VOUT of jumper JP3 must always short together and resistor R4 must always be shorted.
2. RT7238C starts work by providing VIN voltage then turn on EN1 switches. In the RT7238C application, the resistor R4 must always be shorted.
3. RT7238D starts work by providing VIN voltage then turn on EN1 switches. In the RT7238D application, the output voltage can be set by individual resistor R4 and R5. Moreover, the current limit threshold can be chosen through ILMIT\_L and ILMIT\_H switches after the jumper J2, resistor R14, R10 and capacitor C18 are shorted.

**Schematic, Bill of Materials & Board Layout**

**EVB Schematic Diagram**

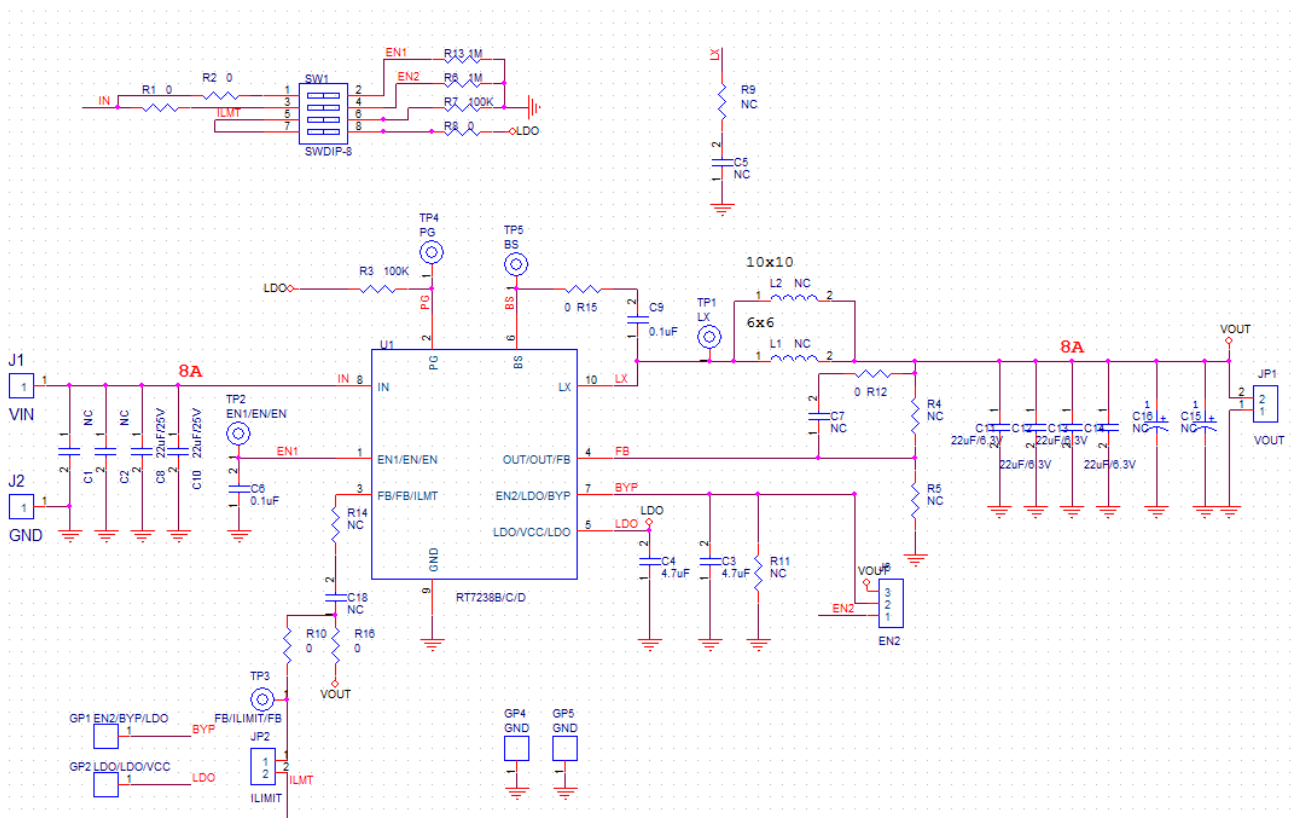

**Bill of Materials**

Reference	Q'ty	Part Number	Description	Package	Manufacture
<b>C3, C4</b>	2	C1608X5R0J475KT000N	4.7 $\mu$ F/6.3V/0603/X5R	0603	TDK
<b>L1</b>	1	7443340100	1 $\mu$ H for RT7238D 2.2 $\mu$ H for RT7238B/C	8 x 8 x 7.5 mm	GOTREND
<b>C6, C9</b>	2	C1608X7R1H104KT000N	0.1 $\mu$ F/50V/0603/X5R	0603	TDK
<b>C8, C10</b>	2	GRM31CR61A226KE19L	22 $\mu$ F/25V/1206/X5R	1206	muRata
<b>C11, C12, C13, C14</b>	4	C3225X5R1E226MT	22 $\mu$ F/25V/1210/X5R	1210	TDK
<b>BYP/EN2/VCC</b>	1	Gold PIN	Gold PIN	Gold PIN	Gold PIN
<b>LDO/VCC/LDO</b>	1	Gold PIN	Gold PIN	Gold PIN	Gold PIN
<b>J1, J2, J3, J4</b>	4	Connector	Connector	Connector	Connector
<b>GND</b>	2	Gold PIN	Gold PIN	Gold PIN	Gold PIN
<b>JP1 ,JP2, J6</b>	3	Jumper	Jumper	Jumper	Jumper
<b>R1, R2, R8, R10, R12, R15, R16</b>	7	Shorted	Shorted	Shorted	Shorted
<b>R3, R7</b>	2	0603 100K 1%	100k $\Omega$ /0603/1%	0603	WALSIN
<b>R6, R13</b>	2	0603 360K 1%	1m $\Omega$ /0603/1%	0603	WALSIN
<b>R4</b>	1	0603 15K0 1%	Shorted for RT7238B/C 15k $\Omega$ /0603/1% for RT7238D (VOUT 1.05V)	0603	WALSIN
<b>R5</b>	1	0603 20K0 1%	20k $\Omega$ /0603/1%	0603	WALSIN
<b>SW1</b>	1	SWITCHES	SWITCHES	SWITCHES	SWITCHES
<b>EN1/EN/EN, PG, FB/FB/ILMIT, BS, LX</b>	5	Test PIN	Test PIN	Test PIN	Test PIN
<b>U1</b>	1	RT7238B/C/D	RT7238B/C/D	UQFN-10L 3x3 (FC)	RICHTEK

**PCB Layout**

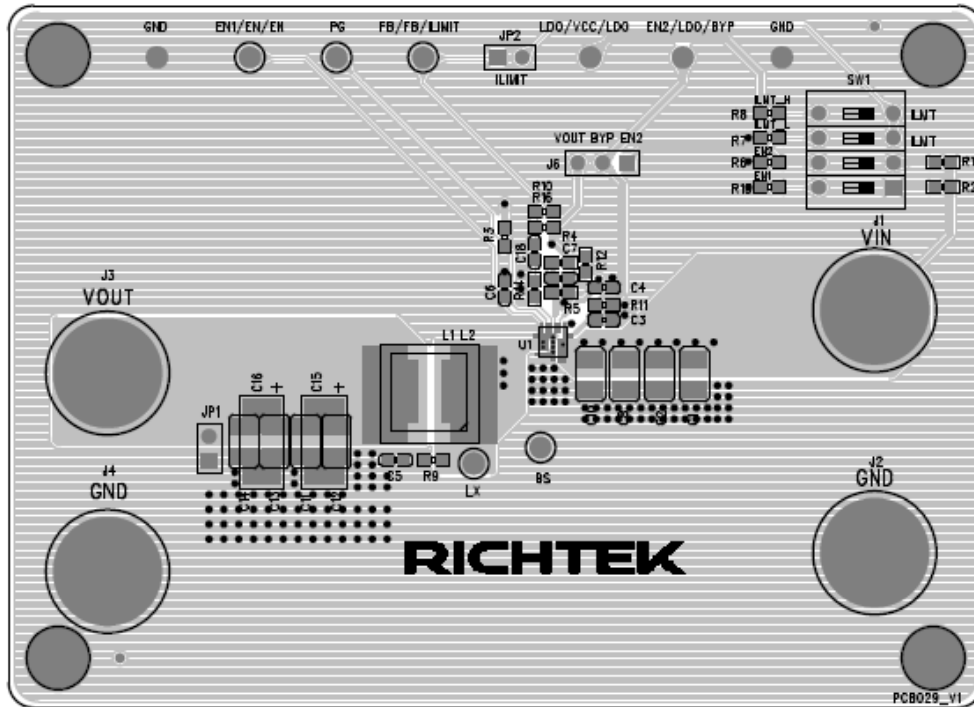

Top View (1st layer)

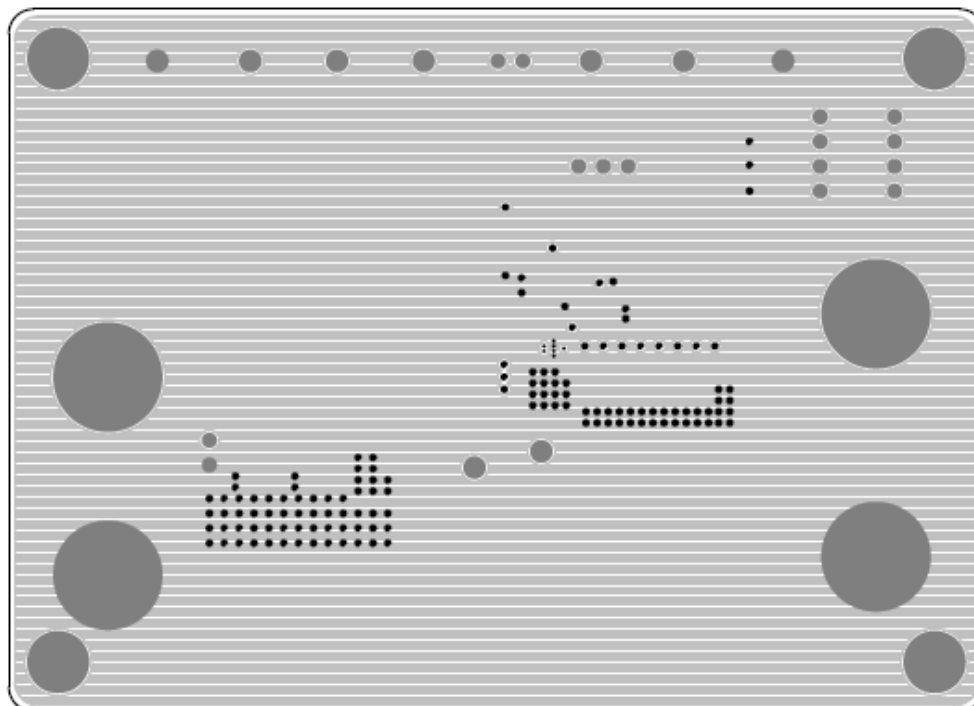

PCB Layout—Inner Side (2<sup>nd</sup> Layer)

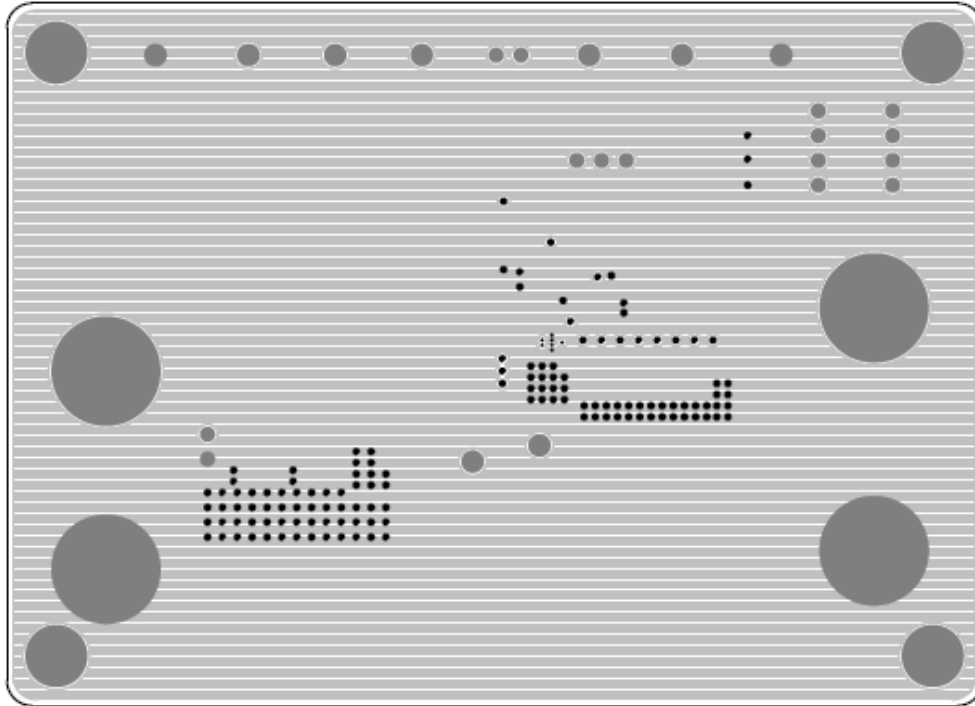

PCB Layout—Inner Side (3<sup>rd</sup> Layer)

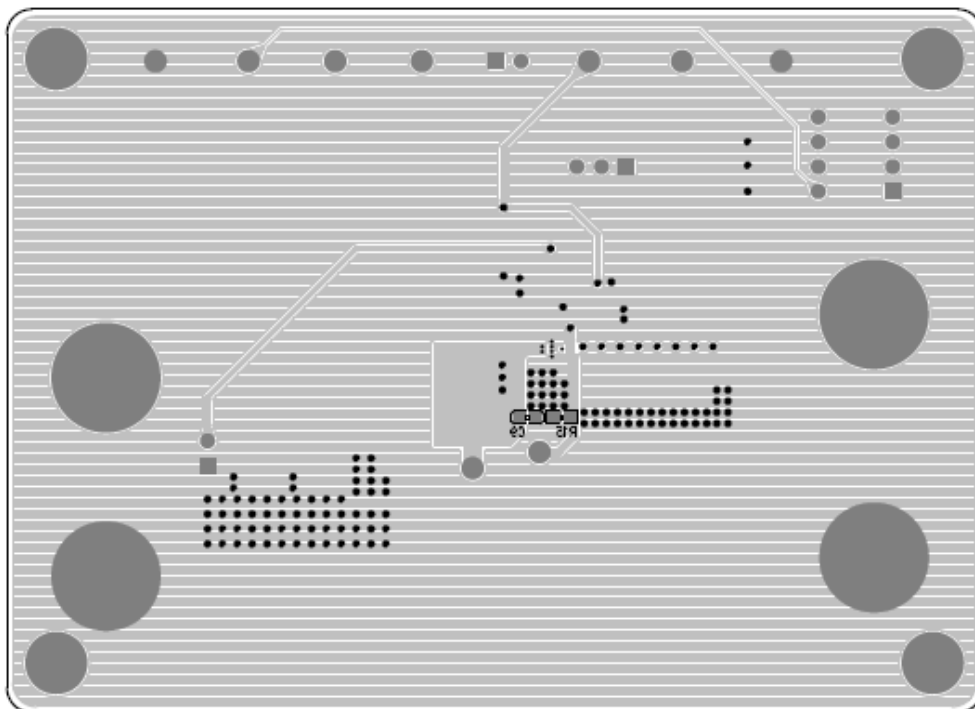

Bottom View (4th Layer)



### ***More Information***

For more information, please find the related datasheet or application notes from Richtek website <http://www.richtek.com>.

### ***Important Notice for Richtek Evaluation Board***

THIS DOCUMENT IS FOR REFERENCE ONLY, NOTHING CONTAINED IN THIS DOCUMENT SHALL BE CONSTRUED AS RICHTEK'S WARRANTY, EXPRESS OR IMPLIED, UNDER CONTRACT, TORT OR STATUTORY, WITH RESPECT TO THE PRESENTATION HEREIN. IN NO EVENT SHALL RICHTEK BE LIABLE TO BUYER OR USER FOR ANY AND ALL DAMAGES INCLUDING WITHOUT LIMITATION TO DIRECT, INDIRECT, SPECIAL, PUNITIVE OR CONSEQUENTIAL DAMAGES.