

8 7 6 5 4 3 2 1

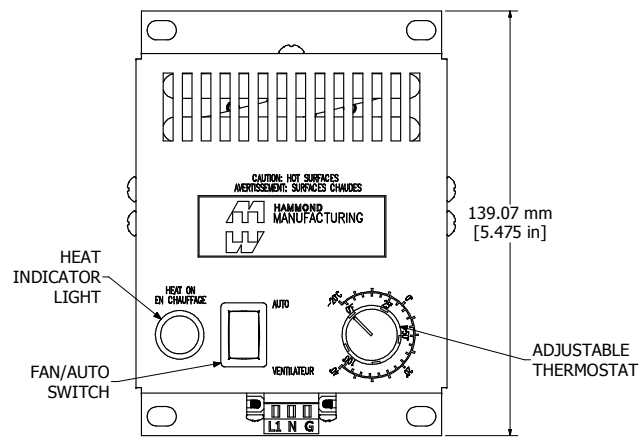

ASSEMBLY - VIEW FROM FRONT

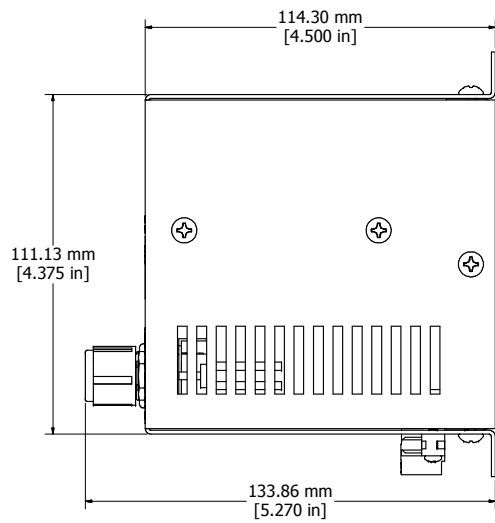

ASSEMBLY - VIEW FROM SIDE

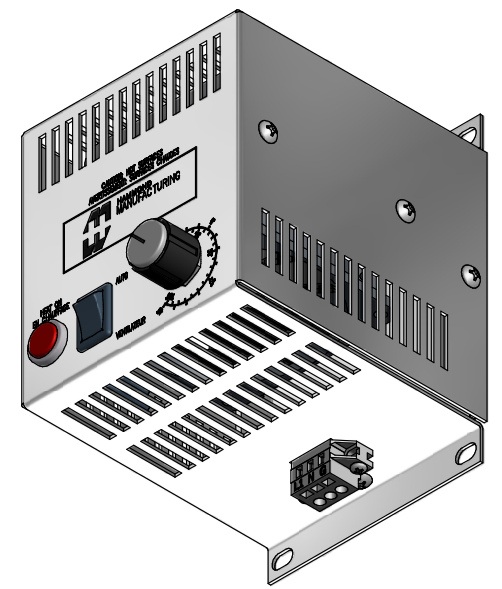

ISOMETRIC VIEW

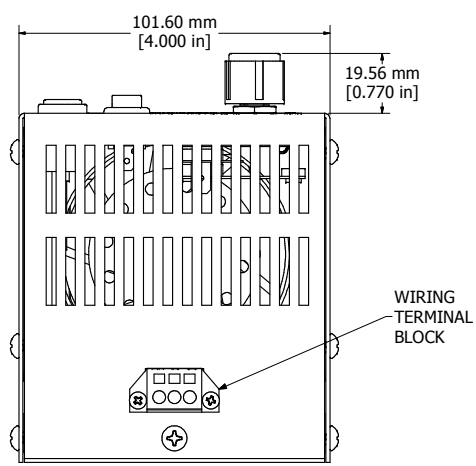

ASSEMBLY - VIEW FROM BOTTOM

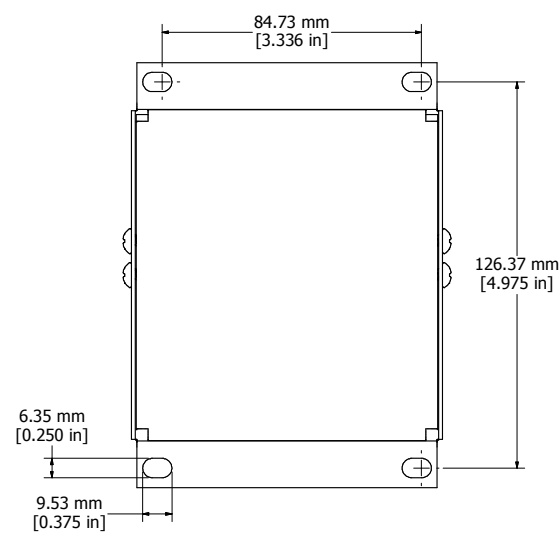

ASSEMBLY - VIEW FROM BACK

FLHTF125A115
Housing - Aluminum Alloy
Rating - 120 VAC, 60 Hz, 125 W
Approvals - UL Recognized Standard UL 508A - CSA Standard C22.2 No. 88

HAMMOND MANUFACTURING™
FLHTF125A115
www.hammondmfg.com

8 7 6 5 4 3 2 1