



Part No: DTS120100SUDC-P5P-SZ

Date: 4/06/2006

Unit: mm

Description: switching power supply

Page No: 1 of 7

## Input

Rated input voltage	100 V ~ 240 V ac
Input voltage range	90 V ~ 264 V ac
Rated frequency	50~60 Hz
Frequency range	47~63 Hz
Rated input current	300 mA RMS max.
Inrush current	30 A max. at 115 / 50 A max. at 230 V ac cool start

## Output

Output voltage	12 V dc at 1 A
Output min. current	0 A
Line regulation	± 1%
Load regulation	± 5%
Over voltage protection	15 ~ 18 V dc max. (output shut down)
Short circuit protection	output shut down and auto restart
Ripple voltage	150 mV (p-p) (100~240 V ac at full load)
Efficiency	60% min.

## Safety and EMI

HI-POT	input to output	3000 V ac or 4242 V dc at 10 mA for 1 min.
Insulation resistance	input to output	> 100 M Ohm at 500 V dc
Safety approvals	UL/cUL, GS, CE	
EMI standard	meets FCC class B, CE, VCCI-II	
RoHS compliant	yes	
Leakage current	0.25 mA	

## Environmental

Storage temperature	-10°C ~ +70° C
Operating temperature	0°C ~ +40° C
Storage humidity	10~90%
Operating humidity	20~80%



**Label**

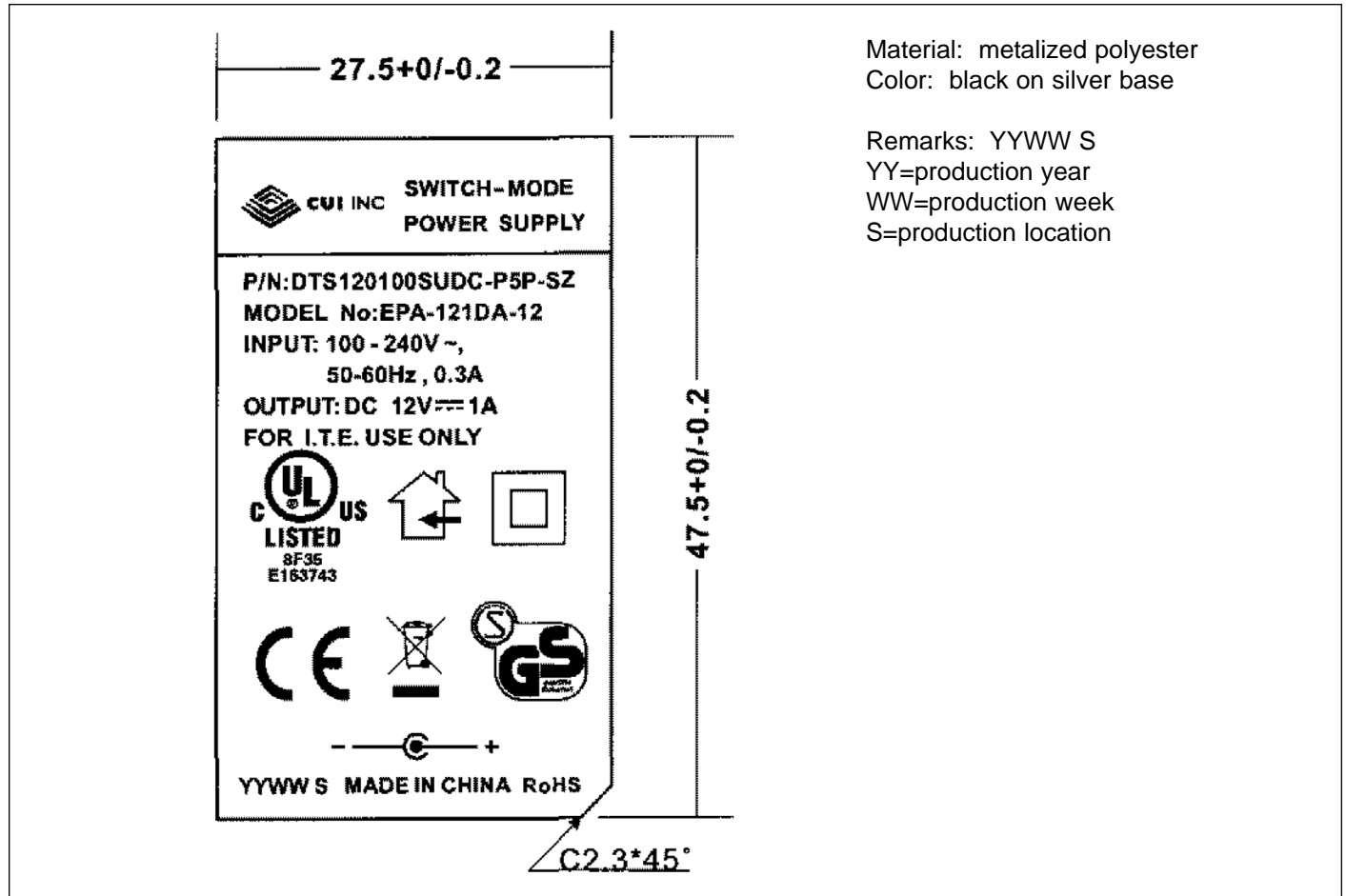

**Mechanical Drawing**

 Tolerance:  $\pm 1$ 

Input plug

Inlet IEC320/C8-2 Type

Case size

75 L x 46.5 W x 26.5 H mm

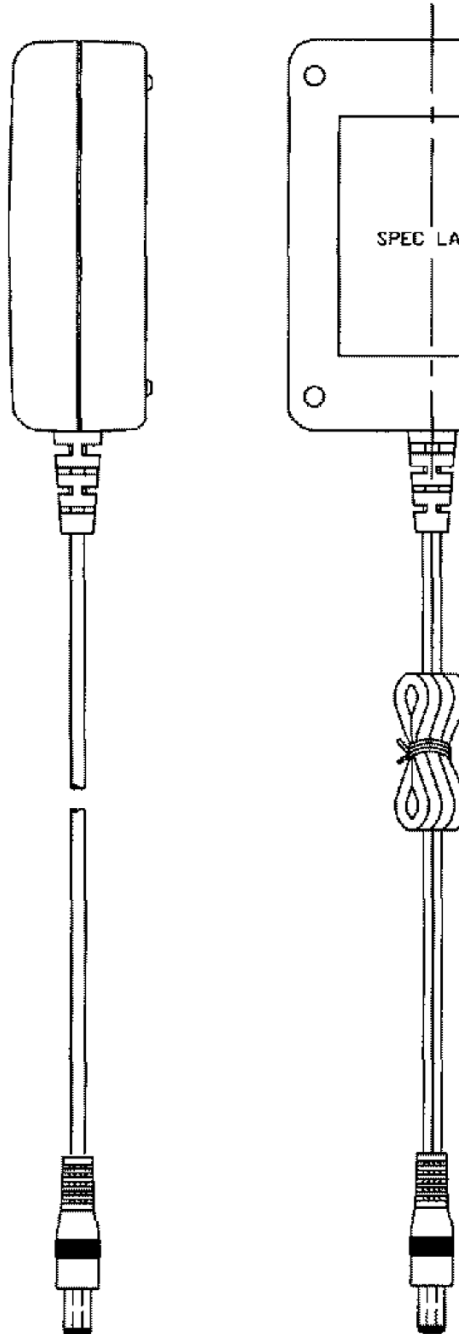
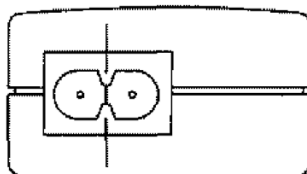
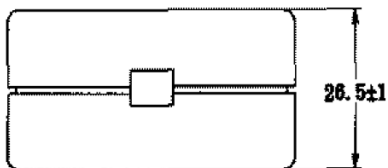
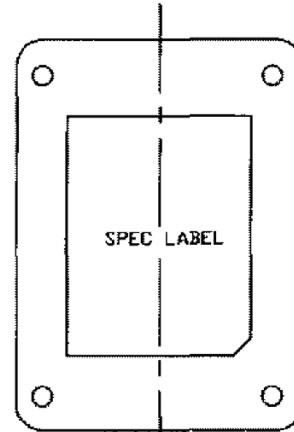
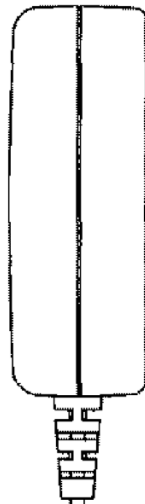
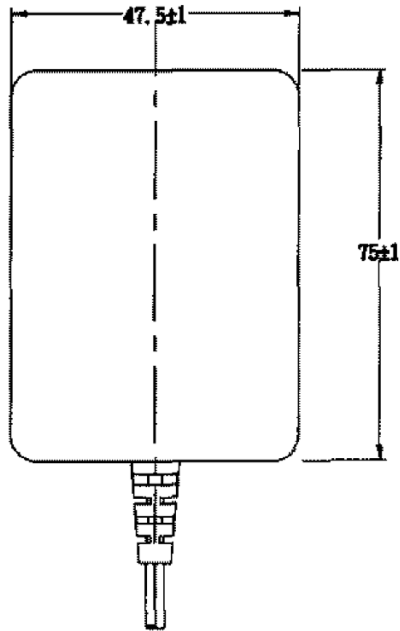



DC Cord

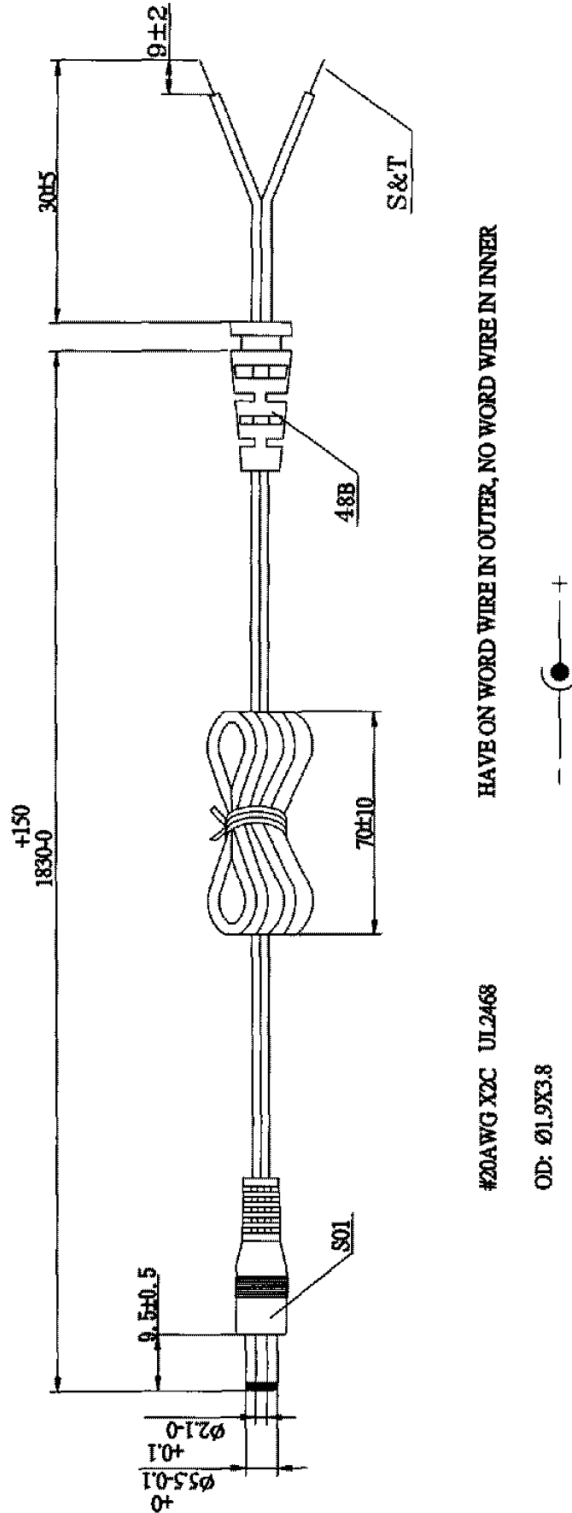



AC Cord

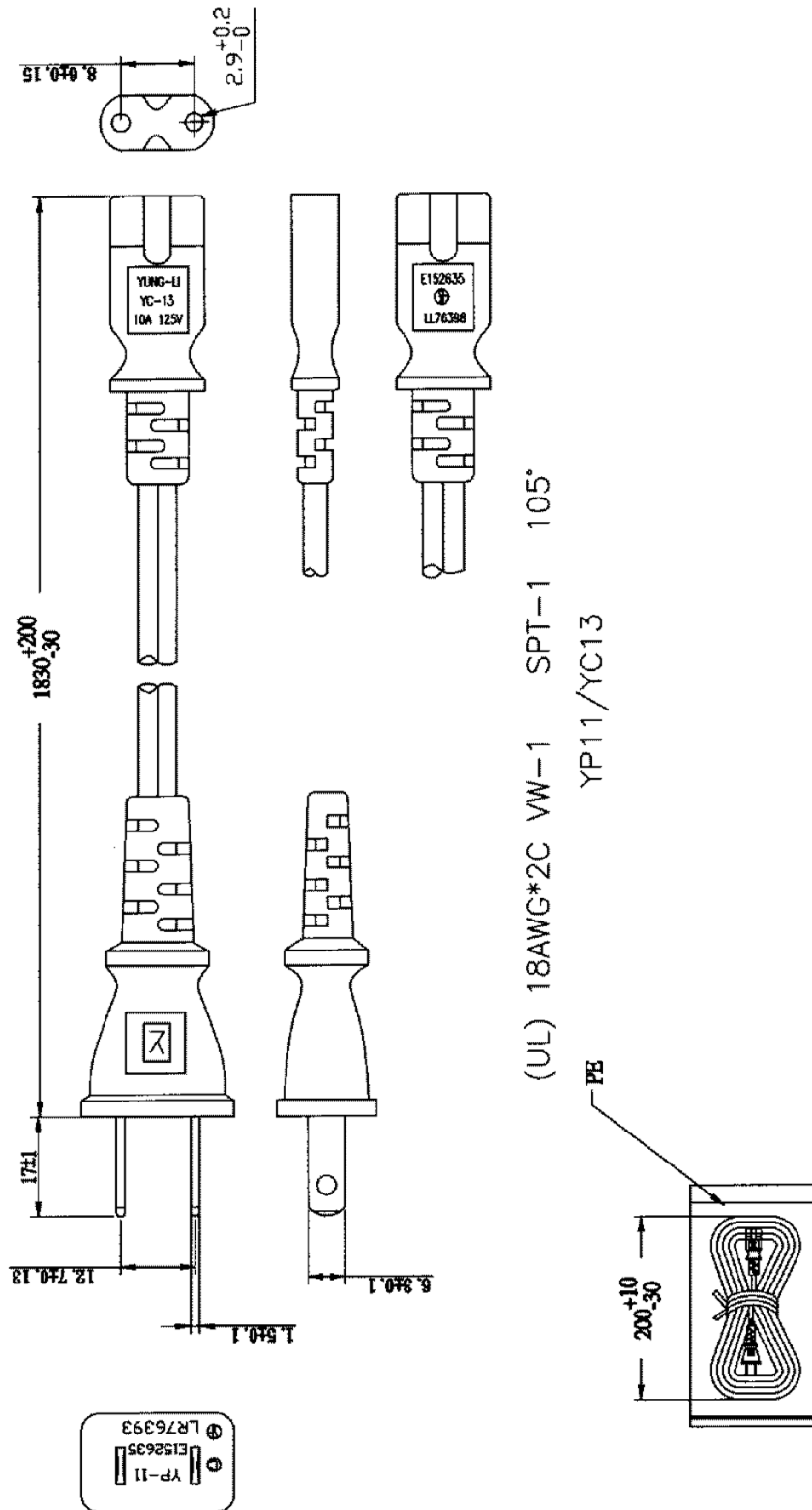



**CUI INC**

Part No: DTS120100SUDC-P5P-SZ

Date: 4/06/2006

Unit: mm

Description: switching power supply

Page No: 6 of 7

### Individual Packaging

Tolerance:  $\pm 1$



AC CORD

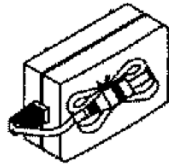

product

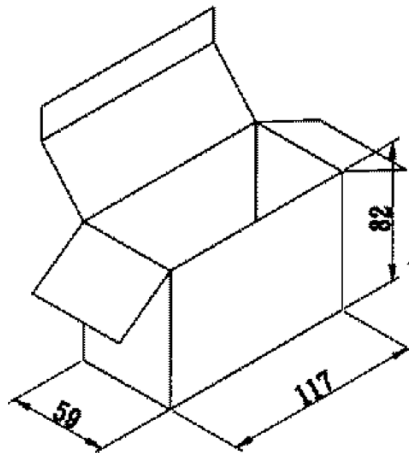

"RoHS Compliant"



**Packaging**

Tolerance: +7/-0

**CARTON SIZE: 365\*310\*343mm**

**QTY: 60PCS(15\*4)**

**"RoHS Compliant"**

